

扫描二维码查看详情



WEB



With partners across China and the world,
NORTH has a truly national and international
understanding and unparalleled collective expertise.

Jinan North Welding & Cutting Tools Co Ltd
济南诺斯焊割辅具有限公司
No.25 XinMaoQiLu Sci-tech Zone Zidong Road Tianqiao Zone Jinan 250121
Shandong, P.R. China
中国山东省济南市天桥区桑梓店鑫茂齐鲁科技城25号
China Sales (销售部) : 0531 8801 0828 / 0531 8866 7989
Fax (传真) : 0531 88662287

A Welding and Cutting Torch Series for Everyone [™]
northweld.com

All Trademarks / Part Numbers printed in this catalogue are the property of their respective owners and are for reference purposes only. All Trademarks / Part Numbers are in no way connected or affiliated with Jinan North Welding & Cutting Tools Co Ltd. Specification / Product Information / Product Appearance are subject to change without notice. Please refer to www.northweld.com for the most up-to-date data.

NC005-02-0422

PRODUCT OVERVIEW 2021

MIG/MAG/TIG/PLASMA
WELDING & CUTTING



济南诺斯
Jinan North



NORTH系列产品涵盖了市场的所有焊割需求,为客户提供全套的MIG/MAG焊枪、等离子割枪、TIG焊枪等。2010年被中国电器协会电焊机分会评为唯一一家专业生产焊枪产品的常务理事单位,全国电焊机行业标准委员会委员,焊枪标准行业第一起草单位。

NORTH series of products covers all the welding and cutting needs of the market, providing customers with a full range of MIG/MAG , plasma , TIG torches, etc. In 2010, the company was rated as the only standing director unit specializing in the production of welding torch products by the Welding Machine Branch of China Electrical Appliance Association, also a member of the National Welding Machine Industry Standards Committee, and the first drafting unit of welding torch standards industry.

NORTH一直致力于研究和开发,这直接体现在焊枪、割枪的品质、性能、服务上。提高性能和改进产品的功能性是研发部的主要目标。在行业领域中确立重要的口碑,有助于提高公司在全球参与者中的声誉。我们一直在改进与创新,并且应用在在质量控制中。

North has always been committed to research and development, which is directly reflected in the quality, performance and customer servicing. Improving performance and improving product functionality are the main goals of the R&D department. Establishing a significant reputation in the industry will help enhance the company's reputation among global market. We are always improving and innovating, also applying in quality control.

我们一直以公司是一个专注于设计和制造团队而自豪。近年来,公司面貌发生了很大的变化,但是我们的创新和诚信的核心价值观没有改变。创新的视野及优秀的团队精神促使我们实现了符合中国的焊枪使用标准,并且是唯一达到这一标准的公司。我们为制造商制造产品,所以我们深刻理解并致力于为客户提高生产力而努力,设计出最大化产出的工具以减少客户停机时间,更好的为客户服务。

North has always been committed to research and development, which is directly reflected in the quality, performance and customer servicing. Improving performance and improving product functionality are the main goals of the R&D department. Establishing a significant reputation in the industry will help enhance the company's reputation among global market. We are always improving and innovating, also applying in quality control.

***Need a great bead
on your next welding
& Cutting project....***

Let our torch weave its magic

North-Digi Mig 全数字系列MIG焊枪

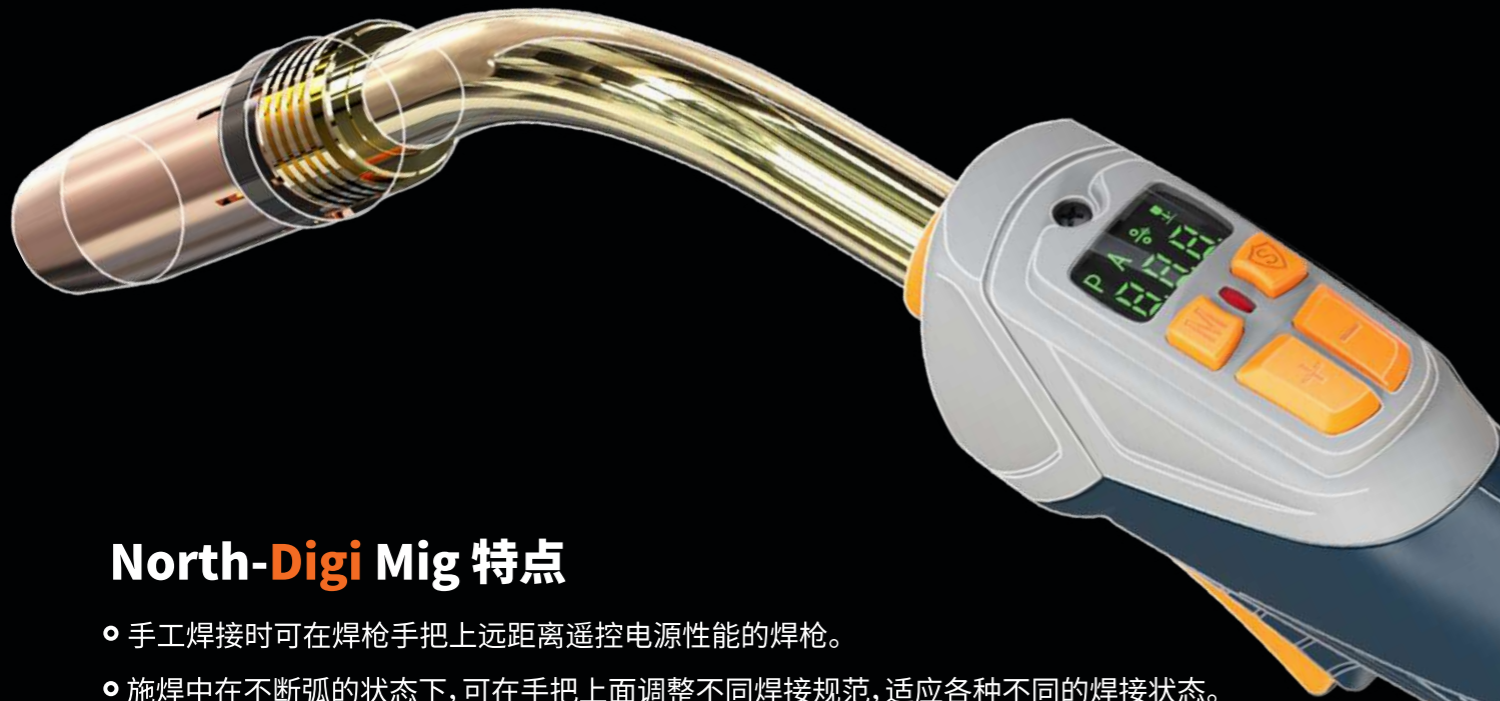

North-Digi Mig 特点

- 手工焊接时可在焊枪手柄上远距离遥控电源性能的焊枪。
- 施焊中在不断弧的状态下,可在手柄上面调整不同焊接规范,适应各种不同的焊接状态。
- 焊枪调整是采用载波通信方式与焊机进行连接。响应速度快,安全可靠。
- 焊枪与焊机不需增加任何连接线,可以遥控实现焊机专家程序的采集和调用。
- 操作者可通过焊枪上面的液晶显示屏,时刻观察了解到焊接电流的大小,及时调节补偿。

North-Digi Mig offering high tech control of the welding parameters by digitally interfacing with all machine control features from the torch handle.

可适配枪型与对应的手柄

此模块可与Selekt系列 BZL / PNA / BRD / TWE 枪型手柄相适配。



Digi Mig 模块功能介绍

- ①. 当数据传输出现问题时,LED警示灯闪烁。
- ②. 按住安全保护按钮3秒以上可以点亮或者熄灭LED警示灯。当LED警示灯熄灭时,可以操作左、右按钮,当LED点亮时,任何操作模式按钮与左、右按钮都无法使用。
- ③. 此模块可以在四种模式下工作,有四个模式指示灯显示当前激活的模式。
- ④. 在每种模式下,按右键可增加选定参数,按左键可减小选定参数。
- ⑤. 在每种模式下,按住右键可连续增加所选参数,按住左键可连续减小所选参数。
- ⑥. 数字显示屏实时显示所选参数。

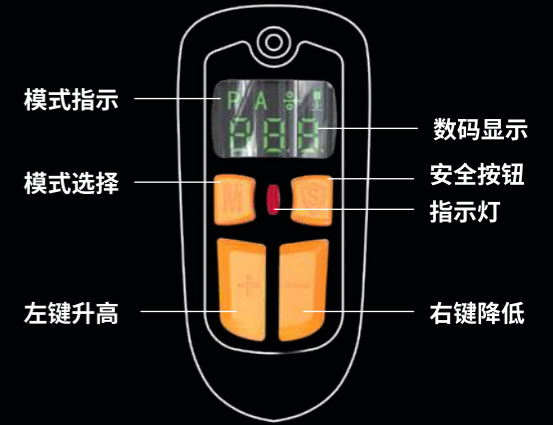

P 程序选择模式 **A** 电流调节 送丝速度调节 弧长调节

可适配多种后尾

此模块可适配 标准欧式后尾 / 标准松下后尾 / 美式后尾 / 根据要求定制的其他后尾样式。



KLASIK TIG WELDING



TORCHES

**RUGGED DESIGN,
LIGHTWEIGHT, &
DURABLE.**

**PERFECT FOR A BALANCED
BUDGET AND QUALITY
PERFORMANCE.**



Connections for all
types of welding
machines.

Very flexible rubber
cables with a high
insulation level.



Available with valve,
flexible torch bodies,
flexible torch bodies with
valve and "Free" without
button.

Consumables com-
patible to the inter-
national standard.

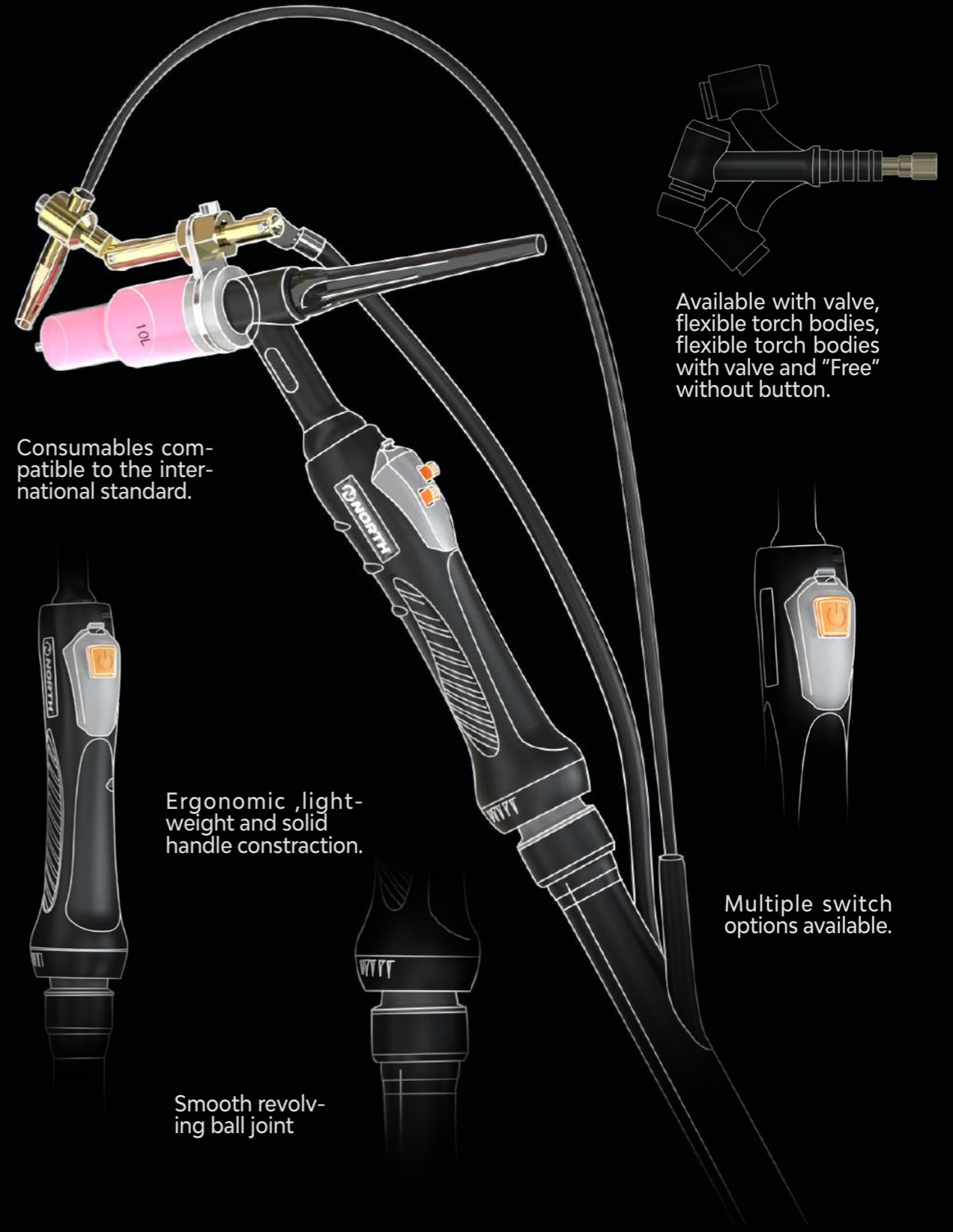
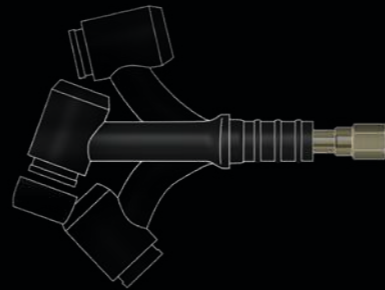

Consumables com-
patible to the inter-
national standard.

Ergonomic, light-
weight and solid
handle construction.

Smooth revolv-
ing ball joint

Available with valve,
flexible torch bodies,
flexible torch bodies
with valve and "Free"
without button.



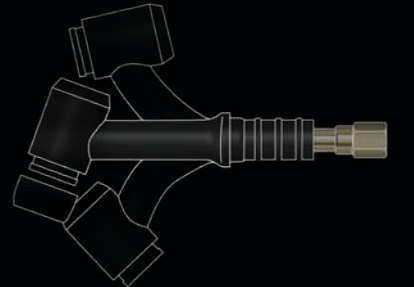





Multiple switch
options available.











GOOD VALUE TRIED AND TESTED.

TIG Torch

WP

 WP9 60% 125A DC 100A AC	 WP17 60% 150A DC 125A AC	 WP18 100% 350A DC 270A AC	 WP20 100% 250A DC 220A AC
 WP24 60% 110A DC 95A AC	 WP24W 100% 180A DC 120A AC	 WP25 100% 250A DC 220A AC	 WP26 60% 200A DC 150A AC
 WP12 100% 500A DC			

KLASIK

 KT9 60% 125A DC 100A AC	 KT17 60% 150A DC 125A AC	 KTW18 100% 350A DC 270A AC	 KTW20 100% 250A DC 220A AC
 KT24 60% 110A DC 95A AC	 KTW24 100% 180A DC 120A AC	 KTW25 100% 250A DC 220A AC	 KT26 60% 200A DC 150A AC
 KTH17 60% 150A DC 125A AC	 KTHW18 100% 350A DC 270A AC	 KTH26 60% 200A DC 150A AC	

Magnifik

 MTH17 60% 150A DC 125A AC	 MTHW18 100% 350A DC 270A AC	 MTH26 60% 200A DC 150A AC
---	---	---

CONNECTIONS

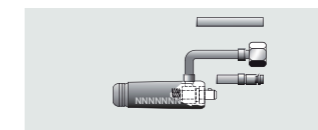
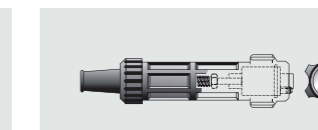
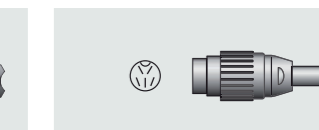
CENTER ADAPTORS 	CONNECTORS 	SPECIFIC CONNECTIONS 	ELECTRIC PLUGS 
---	--	--	--



CONSUMABLES & SPARES

TUNGSTEN ELECTRODES 	TORCH HEADS 
--	--

CONSUMABLES & SPARES

CONSUMABLES 	CONSUMABLES KIT 	MASTER KIT 
---	---	--

QUICK CONNECTORS

QUICK CONNECTORS 	REDUCTIONS 	CABLE CONNECTORS 
--	--	--

KLASIK Plasma Cutting TORCHES



IT'S ALL IN THE DETAILS!



CNC machined consumables part and aerospace polymers.

Comfortable ergonomic handle. 100% quality virgin material used.

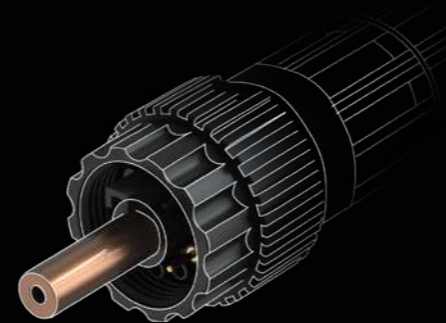

Terminations are offered in a "direct to machine" or central connector configuration.

Spiral design helps support the cable and offer great all day comfort use.

A mechanical lever fitted to the trigger for user safety.

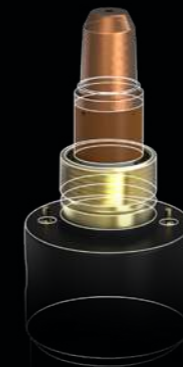

CNC machined consumables part and aerospace polymers.

Solid handle design.

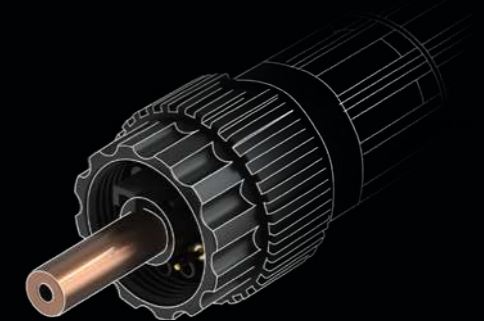

Terminations are offered in a "direct to machine" or central connector configuration.

PERFECT FOR A BALANCED BUDGET AND QUALITY PERFORMANCE.

Heavy duty metal jacket with hi conductivity inner copper tube.

GOOD VALUE TRIED AND TESTED.

Plasma Cutting Torch

NS	 NS25 25A 60%	 NS25K 20A 35%	 NS35K 32A 35%	 NS45 40A 60%
	 NS65 60A 60%	 NS75 70A 60%	 NS80 80A 60%	 NS105 100A 60%
	 NS125 120A 60%			
NA	 NA81 80A 60%	 NA101 100A 60%	 NA141 140A 60%	 NA151 150A 60%
CB	 CB50 50A 60%	 CB70 70A 60%	 CB100 100A 60%	 CB150 150A 60%
NP	 PT31 30A 60%	 SG55 60A 60%	 AG60 60A 60%	 NP80 80A 60%

NU	 NU35K 30A 35%	 NU45 40A 60%		
CBP	 CB100P 100A 60%	 CB150P 150A 60%		
NSP	 NS75P 70A 60%	 NS80P 80A 60%	 NS105P 100A 60%	 NS125P 120A 60%
	NAP	 NA81P 80A 60%	 NA101P 100A 60%	 NA141P 140A 60%
NW	Coming Soon...			
	 NW130	 NW160	 NW200 200A 100%	

Without High Frequency 高频等离子割枪

High Frequency 高频等离子割枪



Plasma Cutting Torch

NT 300

CONNECTIONS

PIN CONNECTIONS



CENTER ADAPTORS



CONSUMABLES

ELECTRODES



DIFFUSERS



TIPS



STAND OFF GUIDES



NOZZLES



NT300- 智能 TIG 送丝机

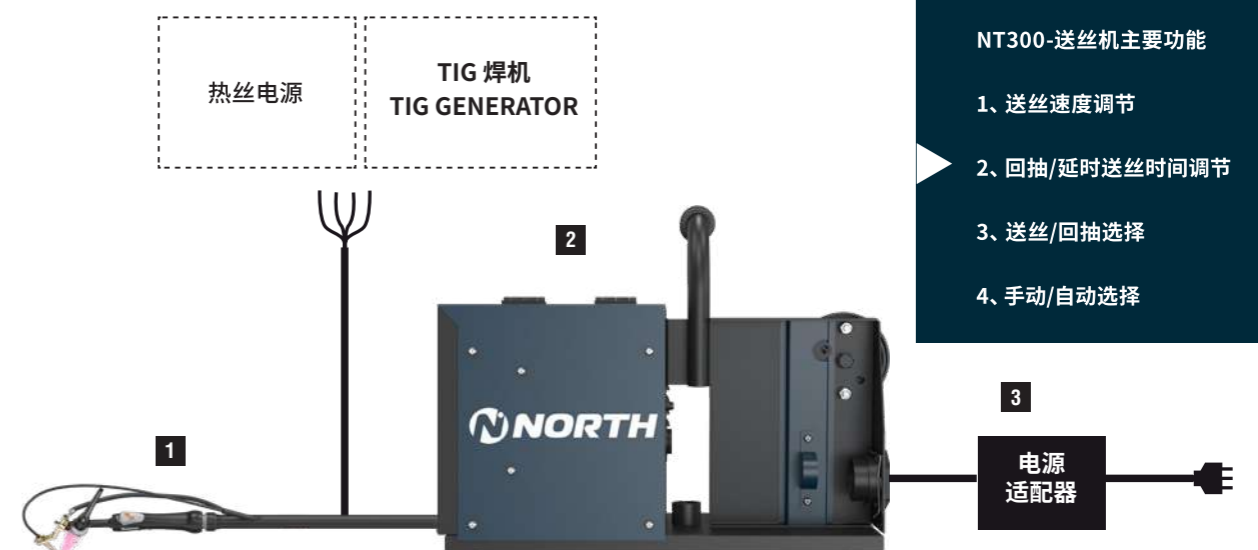

- NT300-送丝机主要功能**
- 1、送丝速度调节
 - 2、回抽/延时送丝时间调节
 - 3、送丝/回抽选择
 - 4、手动/自动选择

Technical Data 参数		No.	Part No.	Description
型号	NT300	1	NSR1407S	送丝 TIG18-4 米
送丝机电压	AC~24V		NSR1410S	送丝 AUTOTIG18-4 米
电源电压	AC~220V		NSU1407S	送丝 TIG20-4 米
送丝速度	0-10m/min		NSK1407S	送丝 TIG26-4 米
送丝直径	0.8-1.6mm	2	NMU0500	NT300-TIG 送丝机
额定送丝力	200N	3	NBX0500	AC~220V 转 AC~24V 电源适配器
适配焊丝盘	50X300X103 (轴径 X 外径 X 宽度)			
适用焊丝类型	不锈钢、软钢实芯 (铝丝) 等			
适配焊丝重量	≤ 20KG			
送丝机重量	10KG			
防护等级	IP23			
外形尺寸	480X200X270mm			



Technical Data 参数					
TIG 20		TIG 26		AUTOTIG 18	
冷却方式	水冷	冷却方式	空冷	冷却方式	水冷
保护气	氩气	保护气	氩气	保护气	氩气
暂载率	100%	暂载率	35%	暂载率	100%
最大电流	250A DC~220A AC	最大电流	200A DC~150A AC	最大电流	350A DC~270A AC
水压	4Bar			水压	4Bar
水流量	1.5L/min			水流量	1.5L/min